

BIGASUO

MODEL NO: PRO302

MULTIMEDIA PROJECTOR User Manual



Contents

Foreword	2
Important safety instructions	2
Notes & Tips	3
Additional Warnings and Precautions	3
Package Listing	4
Remove and close the lens cover.....	5
Place your projector	5
Place your projector on the ceiling	6
Distance between the projector and screen	6
To reduce image distortion	6
Adjust the vertical position	7
Adjust the focus and keystone	7
Remote control	8
Install / remove the remote control battery	9
Controls of the projector	10
Main Operation	11
Install power adapter	11
Menu option: Picture	12
Menu option: Sound	13
Menu option: Option	14
Menu option: Time	15
Connected to the smartphone	16
Connect to Apple MacOS system computer	17
Connect PC/TV Box via HDMI / VGA interface	17
Problems when connecting smart devices	17
Using Bluetooth Playback	18
Connect HDMI	19
Connect AV	19
Connect VGA	20
Connect Audio Output (Aux Output / Line Out / Headphone)	21
Install USB Device and Micro SD Card	21
Using the TF Card and USB playback (Media Player)	22
Using DVD playback	23
Specifications	24
Troubleshooting	25
Warranty	25

Foreword

Dear Customer:

Hello, thank you for supporting our products. For us, BIGASUO focuses on the shopping and usage experience of each customer.

Our products are subject to rigorous technical review before they are shipped out of the warehouse. However, it is inevitable that it will be damaged during transportation, which is unavoidable. Transportation may result in:

1. Some parts of the machine fail;
2. Drop dust inside the lens, which will cause black spots in the projected image (only shaking the projector has a chance to remove the dust);
3. The focus adjustment gear or the trapezoidal correction gear is out of order.

For more questions, please contact our customer service in the first time and we will reply within 12 hours. Best solution will be also followed soon to ensure your profit.

The product quality and performance is always in the update, we are devoted to solve any technical issue.

Important safety instructions

1. Read these instructions.
2. Keep these instructions.
3. Pay attention to all warnings.
4. Follow all instructions.
5. Do not use this unit near water.
6. Clean only with a dry cloth.
7. Do not block ventilation openings. Install in accordance with the manufacturer's instructions.
8. Do not install the unit near heat sources such as radiators, heaters, stoves, or other equipment (including amplifiers) that heat the product.
9. Protect the power cord from being crushed or crushed, especially at plugs, sockets, and at the point where it exits the unit.
10. Use only manufacturer-specified accessories / accessories.
11. Pull out the device during a thunderstorm or when not in use for a long time.
12. Leave all maintenance to qualified service personnel. Maintenance is required if the device has been damaged in any way, eg. For example, if the power cord or plug is damaged, liquid spilled or objects have fallen into the product, the product has been exposed to rain or moisture, does not operate normally, or has been deleted.
13. Use only a cart, stand, tripod, bracket, or table specified by the manufacturer or sold with the unit. If a cart is being used, be careful when moving the cart / implement combination to avoid tipping over.



Notes & Tips

1. Do not look directly into the projector lamp. Do not touch the objective lens. The AC adapter is used as a disconnect device and should remain operational during normal use. To completely disconnect the device from the mains, the mains plug should be completely disconnected from the socket.

2. Blurry Image

Adjust the keystone, focus ring, and the projection distance.

3. USB/TF Unrecognized

Make sure your USB stick/TF card is not over 32GB.

4. No Sound

Turn off Dolby audio in your device;

If a movie's audio number is "ac3" (Dolby sound), then the sound may not be played (this kind of movie is very rare)

5. The Lamp Off

When projector is overheating, the light will turn off automatically. Please leave the projector to cool for a few moment.

6. Connect the projector to your Smartphone / Ipad.

For Android device, you need a "Micro USB/ Type C to HDMI cable" (Not included) For IOS Device, you need a "lightning to HDMI cable"(Not included)

7. Connect to computer:

Please use the HDMI cable in the package.

The USB interface is used to connect USB Flash Drive.

Additional Warnings and Precautions

1. Do not look directly into the projector light.
2. Don't touch the projector lens
3. Mains adapter is used as disconnect device and it should remain readily operable during intended use. In order to disconnect the apparatus from the mains completely, the mains plug should be disconnected from the mains socket outlet completely.
4. **CAUTION:** Use of controls or adjustments or performance of procedures other than those specified may result in hazardous radiation exposure.
5. **WARNING:** Changes or modified to this unit not expressly approved by the party responsible for compliance could void the user's authority to operate the equipment.
6. **WARNING:** Use of this unit near fluorescent lighting may cause interference regarding use of the remote. If the unit is displaying erratic behavior move away from any fluorescent lighting, as it may be the cause.
7. **WARNING:** Shock hazard - Do Not Open.
8. Caution and marking information is located at the rear or bottom of the apparatus.
9. **WARNING:** To reduce the risk of fire or electric shock, do not expose this apparatus to rain, moisture, dripping, or splashing.
10. Objects fill with liquids, such as vases, shall not be placed on the apparatus.

Package Listing



Projector

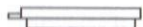

Lens Cover

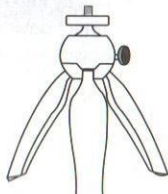

Tripod

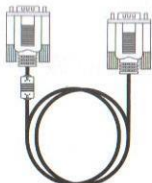

VGA Cable



HDMI Cable

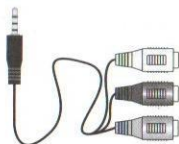

AV Cable

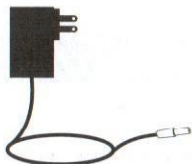

AC Adapter



Remote Control



Carrying Bag



User Manual

Remove and close the lens cover

Remove the lens cover before using

Lens Cover  Remove

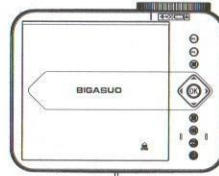

Close the lens cover when unit not using

Lens Cover  Close

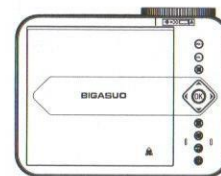

Place your projector

Select location

You can decide where you want to install based on your room layout or personal preferences. Consider the size and position of the screen, the location of the appropriate power outlet, and the location and distance between the projector and the rest of the equipment. The projector can be installed in one of the following locations:

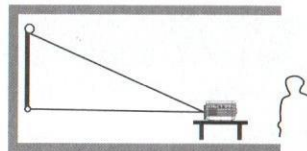

1. Front display on the desk

When this position is selected, the projector is placed directly in front of the screen. This is the most common way to place a projector, and it's fast and mobile.

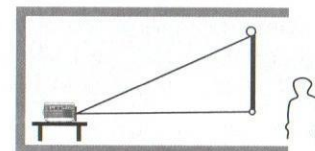

2. Back display on the desk

When this position is selected, the projector is located directly behind the screen. Please note that you need a special rear projection surface.

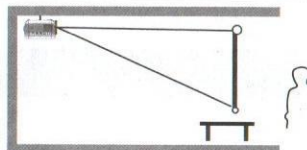

3. Back to display by hanging

When this position is selected, the projector will be hung upside down on the ceiling directly behind the screen. Please note that this installation requires a dedicated rear projection screen and a ceiling mounting kit for the projector.

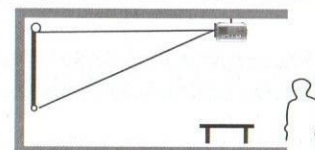

4. Front display by hanging

When this position is selected, the projector is hung upside down directly on the front of the screen. Acquire a special projector ceiling kit from your dealer to mount the projector to the ceiling.

Place your projector on the ceiling

• When installing the projector in the ceiling, please purchase a projector bracket recommended by an installation professional and follow the instructions supplied with the bracket.

• Before installing the projector on the ceiling, please check if the mounting structure can support the weight of the projector and the bracket. If in doubt please consult the advice of an installation.

NOTE: Projector bracket and screw (s) are not included.

FIXED HANGER LOCH
Screw hole type: M6

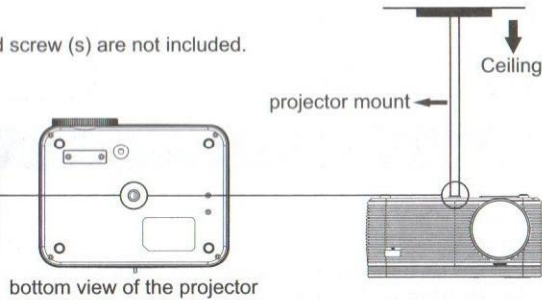

Distance between the projector and screen

It is recommended to move the projector as close as possible to the center of the screen.

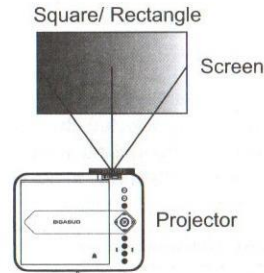

To reduce image distortion

Measure the distance between the projector and the location where you want to position the screen. This is the projection distance.

The best projection distance we recommend: 1.5-2.8m

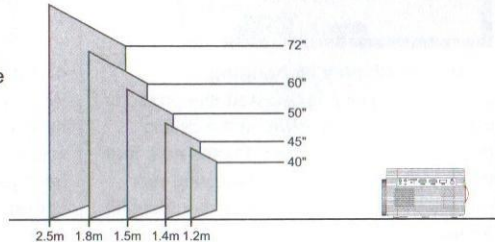

Adjust the vertical position

Follow the picture below to adjust the vertical position.

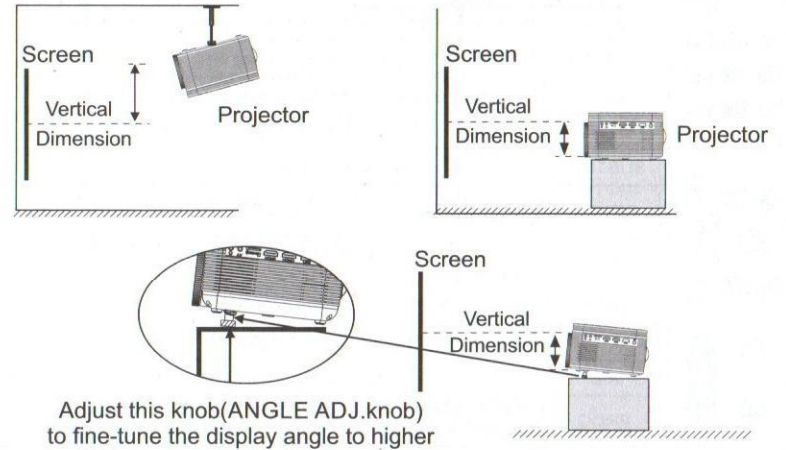

Adjust the focus and keystone

Follow the picture below to adjust the focus and the trapezoidal screen.

Adjust the focus by turning the knob while observing the image pixels near the center of the screen. The optimal focus is achieved when the pixels are clearly visible.

Depending on the projected screen size, the focus near the edges of the screen may be less sharp than in the center of the screen.

The keystone image is created when the projector beam is projected at an angle on the screen. The keystone correction returns the distorted image to a rectangular or square shape.

FOCUS ADJ. KNOB



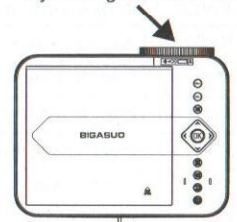



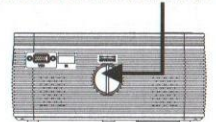









Then sharpen the image by turning the focus knob.



TRAPEZOIDAL ADJ. KNOB



Remote control

	POWER	Press to power ON.
	MUTE	Mute the audio of the player. Press it again to activate the sound.
	RANDOM	Press to random playing for the loaded disc.
	OSD	Press to display the information of the current video/ audio
	ANGLE	On supported DVDs, press and hold to view alternate angles.
	SUBTITLE	Short press to change subtitle mode.
	REPEAT	Press here repeatedly to cycle through repeat options for the loaded disc.
	PBC	Press to activate Play Back Control function only for a VCD disc. Press it again to be off.
	TITLE	Press to view the title menu on a loaded DVD.
	DVD MENU	Press to view the main menu on a loaded DVD.
	A-B	Press to create a repeating loop on a loaded DVD.
	PROG	Program a loaded disc to play chapters and titles or tracks in a specified order.
	SLOW	During playback, press the SLOW button repeatedly to set the slow motion speed. Press OK button to resume.
	SETUP	Press to access the setup menu only for DVD mode.
	SKIP	Press to skip between chapters or tracks.
	SEARCH	Press to search through an individual chapter or track.
	OK	Press to navigate and confirm selections in settings and other menus.

SOURCE	Press to select media source (AV/HDMI 1/ HDMI 2/ VGA/ DVD/MEDIA PLAYER)
DVD	Press to enter the DVD player mode once in other source.
MENU	Press to access projector settings menu.
EXIT	Press to exit the projector menu or the audio/movie playback.
PLAY/PAUSE	Press here to play or pause the audio / movie playback.
STOP	Stop the audio/video /photo playback.
FLIP	Press to rotate/ mirror projector screen.
AUDIO	Press here to switch the available audio channels provided by the disc.
VOL + / VOL -	Adjust the volume up. / Adjust the volume down.
Number Keypad	Number Keypad Enter chapter/title to play.
GO TO	Go to a specific chapter or track numbers. Use play button to begin playing.
ZOOM	Press to adjust the aspect ratio (16:9 / 4:3 / Auto) during playing video from USB/SD/HDMI/VGA.

Install / Remove the remote control battery

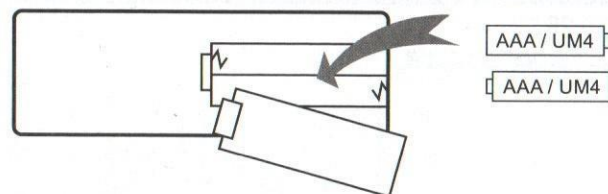

Remove the battery cover on the back of the remote control by gently pushing it open. The battery cover can then be raised. Insert the correct batteries (not included) according to the polarity markings. Finally, replace the cover.

Note:

- Batteries must not be exposed to excessive heat, such as sunshine / fire.
- Make sure that the batteries are installed correctly.
- Do not mix old and new batteries.
- Only use the same or equivalent batteries as recommended.
- Do not dispose of batteries in the fire, the battery could explode or leak.
- Do not try to charge a battery.

Controls of the projector

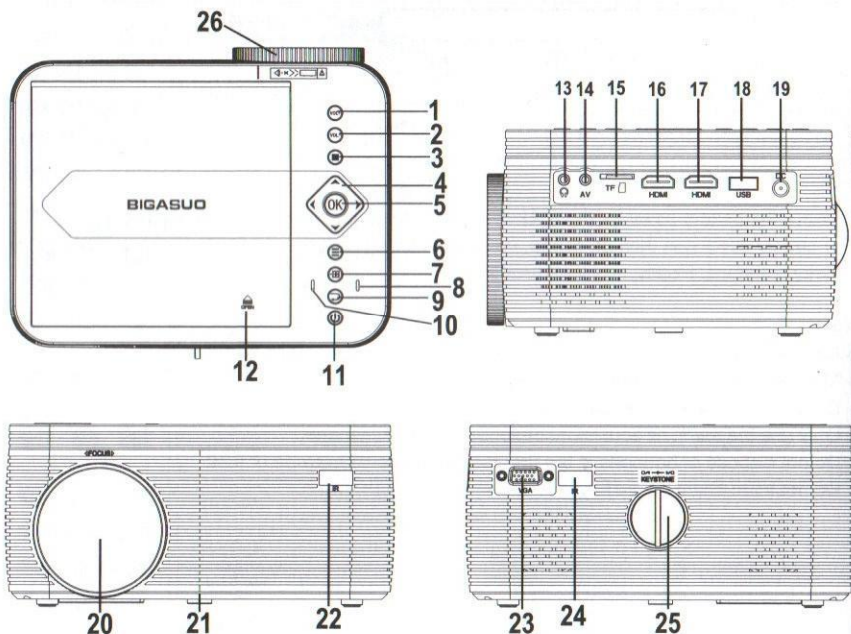

1. VOL+
2. VOL-
3. STOP
4. NAVIGATOR Buttons
5. OK
6. MENU button
7. SOURCE button
8. POWER ON Indicator
9. RETURN button
10. POWER OFF Indicator
11. POWER Button
12. Open disc cover
13. EARPHONE jack

14. AV jack
15. Micro SD card
16. HDMI port 1
17. HDMI port 2
18. USB port(Media player)
19. DC IN jack
20. LENS
21. ANGEL ADJ. Knob
22. IR Window(Front Side)
23. VGA Port
24. IR Window (Rear Side)
25. TRAPEZOIDAL ADJ. Knob
26. FOCUS ADJ. Knob

Main Operation

	POWER	Press the button to turn on the unit and press it again to turn it off.
	SOURCE	Press the button to select the input source.
	MENU	Press the button to enter the projector menu.
		Press the buttons to select the screen element of the projector menu.
	EXIT	Press the button to exit the projector menu.
VOL+ / VOL-		Press the buttons to select the correct sound.
	STOP	Press to stop the audio/video /photo playback.

Install Power Adapter

Follow below picture to connect power adapter.
Connect small end of adapter **FIRST**. Plug the adapter body to power outlet.

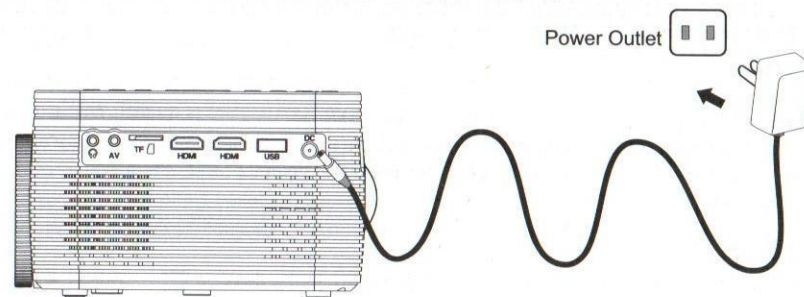

Menu option: Picture

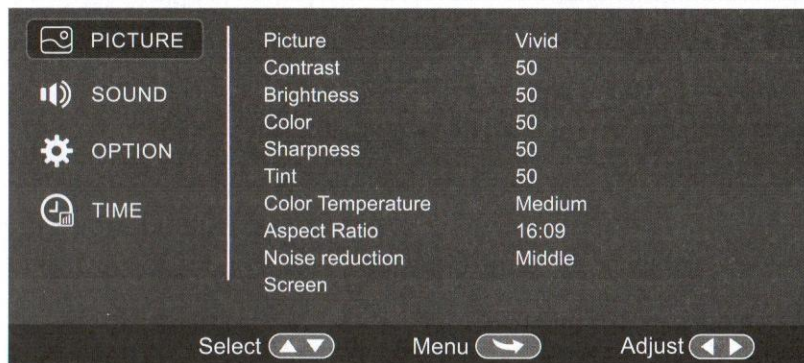

Parameter	Option
Picture mode	Vivid User Soft Standard
Contrast	Value: 1-100
Brightness	Value: 1-100
Color	Value: 1-100
Sharpness	Value: 1-100
Tint	Value: 1-100
Color Temperature	Medium Warm Cool
Aspect Ratio	16:9 4:3 Auto Point to point Panorama Just Scan Zoom 2 Zoom 1
Noise reduction	Middle High Low
Screen	

Note:

User: In this mode, some parameters become variable to manual setting (the font color will turn white). In other modes, the parameter becomes preset and cannot be set (the parameter font color is gray).

Operating

Select: ▲ / ▼ Return to the previous menu: ≡ Return to the desktop: □ Adjust: ◀ / ▶

Menu option: Sound

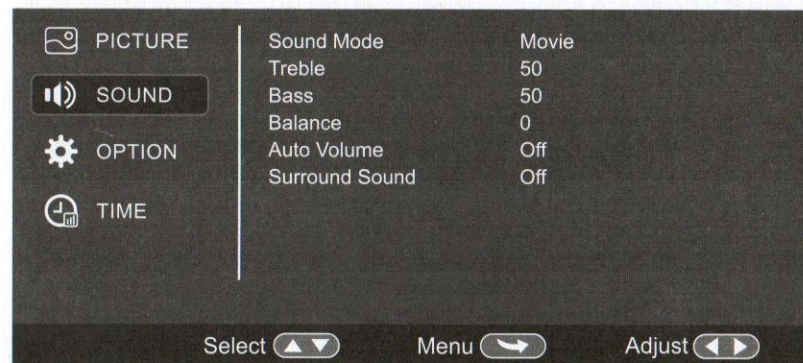

Parameter	Option
sound mode	Movie Sport User Standard Music
treble	Value: 1-100
bass	Value: 1-100
balance	0
auto volume	Off ON
surround sound	Off Surround

Note:

User: In this mode, some parameters become variable to manual setting (the font color will turn white). In other modes, the parameter becomes preset and cannot be set (the parameter font color is gray).

Operating

Select: ▲ / ▼ Return to the previous menu: ≡ Return to the desktop: □ Adjust: ◀ / ▶

How do you know that the operation is in effect?

The selection takes effect based on the selected parameters.

Figure: Surround Sound Off → At this time, the Surround mode is off.

Menu option: Option

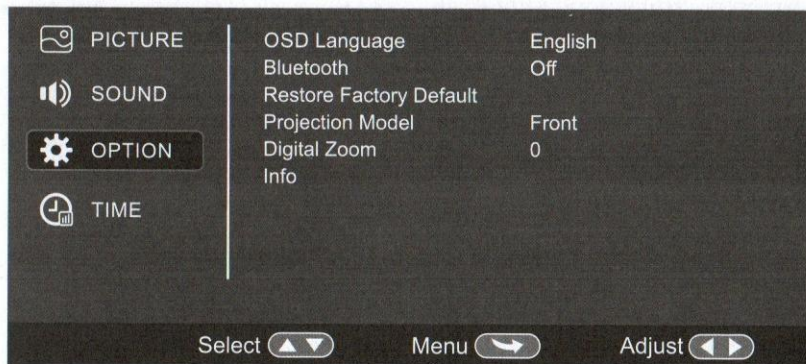

Parameter	Option
OSD Language	Czech English Francais Dansk 日本語 Hrvatski Deutsch Espanol Italiano Magyar Polski Slovenscina Nederlands Portugues Srpski Norsk Romaneste Suomi Svenska Slovensky 中文
Bluetooth	Off On
Restore Factory Default	
Projection Model	Front, Rear, F/Ceiling, Rear/Ceiling
Digital Zoom	0, 8, 16, 24, 32, 40, 48, 56, 64, 72, 80
Info	

Note:
User: In this mode, some parameters become variable to manual setting (the font color will turn white). In other modes, the parameter becomes preset and cannot be set (the parameter font color is gray).

Operating

Select: ▲ / ▼ Return to the previous menu: ☰ Return to the desktop: □ Adjust: ◀ / ▶

How do I know if Bluetooth is turned on?

The selection takes effect based on the selected parameters.

Figure: Bluetooth On → At this time, the bluetooth function is ON.

Menu option: Time

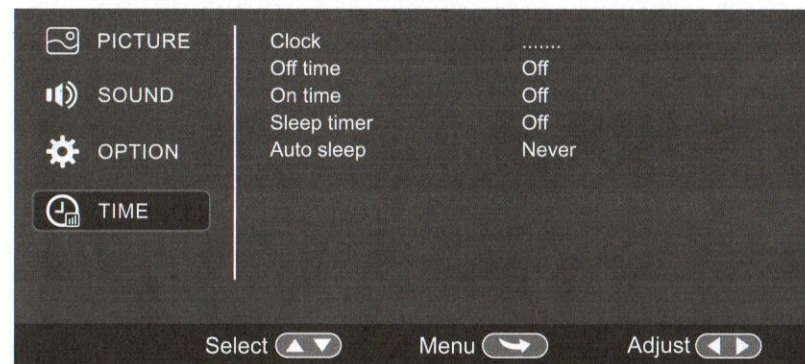

Parameter	Option
Clock	
Off time	Off Once
On time	Off Once
Sleep timer	Off 10min 20min 30min 60min 90min 120min
Auto sleep	Never 4 Hour 6 Hour 8 Hour

Illustration

Clock	Off time	On time	Press ◀ / ▶ to select the range of values.
Date	Day	Hour 00	Date 1-30
Mouth	Hour	Minute 00	Mouth 1-12
Year	Minutes	AV	Year 1----
Hour		...	Hour 1-24
Minute		Volume 30	Minute 1-60
			Volume 1-100

Connected to the smartphone

To connect a tablet, Mac or smartphone, separate cables are required (Not in the package):

Apple iOS device: Lightning to HDMI adapter

Google Android device: Micro USB to HDMI adapter

iOS

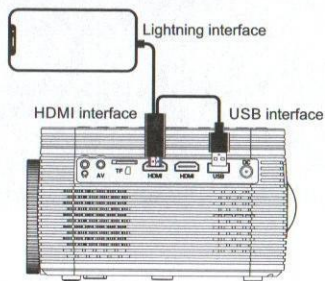

Android

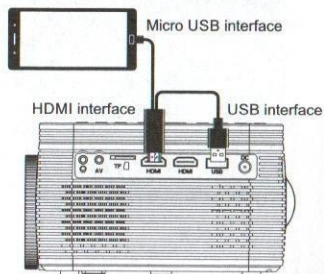

Compatible Devices:



iPhone



iPad



Android

The approximate steps to connect your smartphone.

Before connecting, please make sure that the projector is not connected to the power supply to avoid damage to the device.

- 1) The HDMI connector of the HDMI converter is plugged into the HDMI1/ HDMI2 interface of the projector, and the other end is inserted into the data transmission interface of the smartphone.
- 2) Turn on the projector (when the device is abnormal, you should disconnect the power in time), press the power button on the machine or the power button of the remote control.
- 3) Start to enter the machine initial screen, to enter the homepage, press the "Source" button on the remote control to select the HDMI source (if the projector has multiple HDMI interfaces, please select the corresponding HDMI interface serial number, such as "HDMI 1")
- 4) After selecting the corresponding HDMI source, the screen of the projector and Smartphone are synchronized ! The connection steps for the iPad are similar to connecting a smartphone.

INPUT SOURCE
AV
HDMI 1
HDMI 2
VGA
DVD
Media Player
OK

Connect to Apple MacOS system computer

Connect to Apple MacOS system computer , separate cables are required (Not in the package):

Mac Book Air: Mini Display Port to HDMI Adapter
Mac Book & Mac Book Pro: Type C to HDMI Adapter

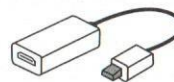

Mini Display Port to HDMI Adapter

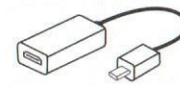

Type C to HDMI Adapter

The approximate steps to connect your Apple MacOS system computer

Before connecting, please make sure that the projector is not connected to the power supply to avoid damage to the device.

- 1) The HDMI interface of the converter is plugged into the interface of the HDMI 1/ HDMI 2 projector, and the other end is plugged into the Type C or Mini Display Port of the computer.
- 2) Turn on the projector (when the device is abnormal, disconnect the power supply in time), press the power button on the machine or the power button to remote control.
- 3) Start to enter the initial screen of the machine, enter the home page, press the "Source" button on the remote control to select the HDMI signal source (if the projector has multiple HDMI interfaces, please select the corresponding HDMI interface serial number, such as "HDMI 1")
- 4) After selecting the corresponding HDMI source, the projector and Computer's screen are synchronized!

INPUT SOURCE
AV
HDMI 1
HDMI 2
VGA
DVD
Media Player
OK

Connect PC/TV Box via HDMI / VGA interface

The steps are similar to connecting a smartphone, except that no extra converters are needed (the VGA cable is in the package).

Problems when connecting smart devices







Dolby, AC3 and stereo sound can not be decoded via the USB and SD ports. We recommend using the HDMI input.

If you have no sound on the Fire TV Stick (APP: Netflix and Prime Video) due to HDCP, please turn off the Dolby output on the TV Stick.

Using Bluetooth Playback





Pairing is used when two Bluetooth devices are connected wirelessly for the first time. This allows the devices to see each other and sets up a one-to-one communication channel between both devices.

Bluetooth Connection:

1. Press the  button to turn on unit.
2. Press the  button to enter the menu screen.
3. Use the  button to select right side menu.
4. Use the  button to select Bluetooth column.
5. Press the  button to enter Bluetooth menu.
6. Use the  button to select "ON"
7. Turn on your External Bluetooth Speaker and select to Bluetooth pairingmode.
8. A few seconds, you hearing "do" sound that your unit and external Bluetooth speaker connected.
9. After connection completed, the unit sound to External Bluetooth speaker.

Note:
When the Bluetooth can't connect to this device automatically. Please enter to the Bluetooth setup menu and select. to the Bluetooth Reset to reset it, after that the BT device will be connected with this Projector automatically.



Disconnect the Bluetooth

1. Press the  button to enter the menu screen.
2. Use the  button to select above menu.
3. Use the  button to select Bluetooth column.
4. Press the  button to enter Bluetooth menu.
5. Use the  button to select "OFF" that the Bluetooth disconnect.

Tip: Bluetooth can not connect to smart devices with Bluetooth capabilities, such as smartphones, laptops, and tablets. Only Bluetooth sound playback devices can be connected.

Connect HDMI

Follow below picture to connect HDMI cable and device.

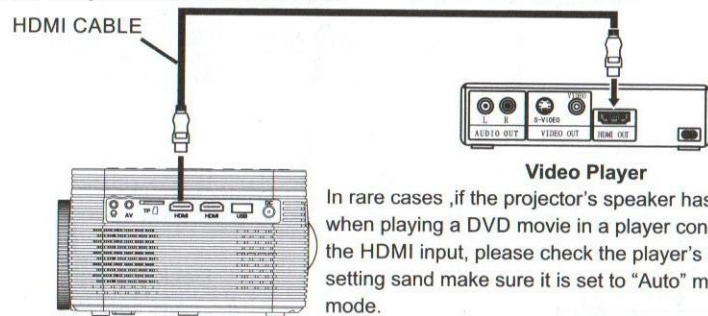

1. Turn off the unit before connect HDMI cable.
2. After connect, press the  button to turn on unit and power indicator will light green.
3. Press the  /SOURCE button to HDMI mode and the video of HDMI device will show on projector screen. There are 2 HDMI input, HDMI1 interface corresponds to HDMI1 in SOURCE mode, and HDMI2 interface corresponds to HDMI2 in SOURCE mode.

HDMI HD signal input: this interface can be input with HD player HDMI output at the connection



Connect AV

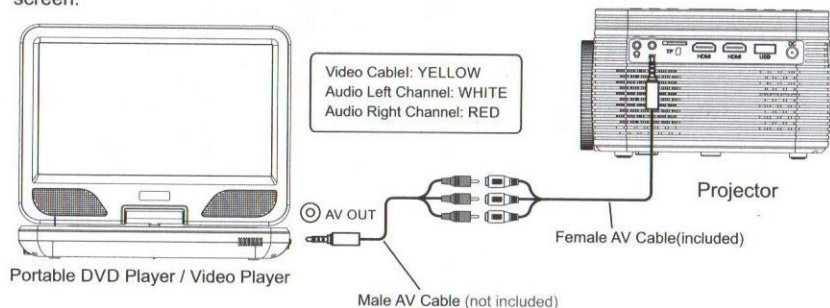

Follow below picture to connect AV cable and device.

1. Turn off the unit before connect AV cable.
2. Connect the end of 3 heads for both Female AV cable and Male AV cable together first, and then connect the other ends of Female cable to the AV IN of projector. Similarly, connect the other ends of male AV cable to the AV OUT of the DVD player or other Electronic device which supported AV out.
3. After connect, press the  button to turn on unit and power indicator will light green.
4. Press the  /SOURCE button to AV mode and the video of AV device will show on projector screen.



Connect VGA

Follow below picture to connect HDMI cable and device

1. Turn off the unit before connect VGA cable.
2. Press the  button to turn off the power of your projector before connection.
3. After connect, press the  button to turn on unit and power indicator light GREEN,
4. Press the  /SOURCE button to VGA device and VGA device will show on projector screen.

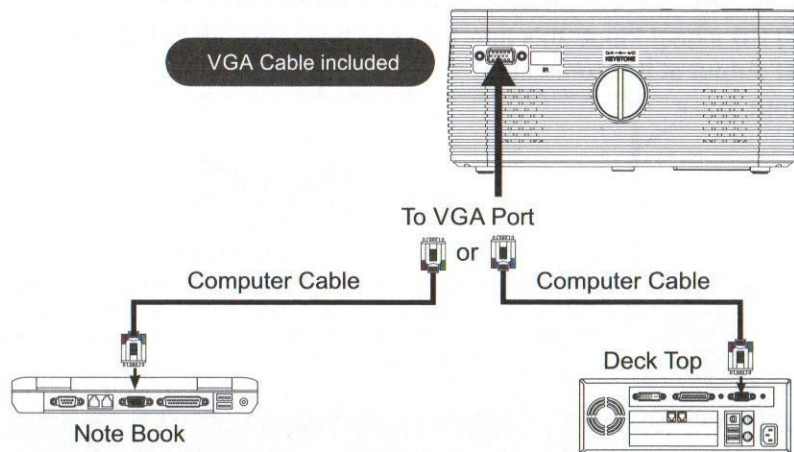

The following table provides information about adjusting the output signal from the computer.

Type	Resolution		Frequency	Field Frequency
PC	VGA	640x480	31.5	60
			34.7	70
			37.9	72
			37.5	75
	SVGA	800x600	31.4	50
			35.1	56
			37.9	60
			46.6	70
	XGA	1024x768	48.1	72
			46.9	75
			40.3	50
			48.4	60
			56.5	70

Connect Audio Output (Aux Output / Line Out / Headphone)

Follow the picture below to connect the HDMI cable and the device.

1. Press the  button to turn off the power of your projector before connection.
2. Use audio cable to connect follow below figure.
3. After connect and turn on both units. Your projector sound from external device now.
4. After using, turn off both unit.

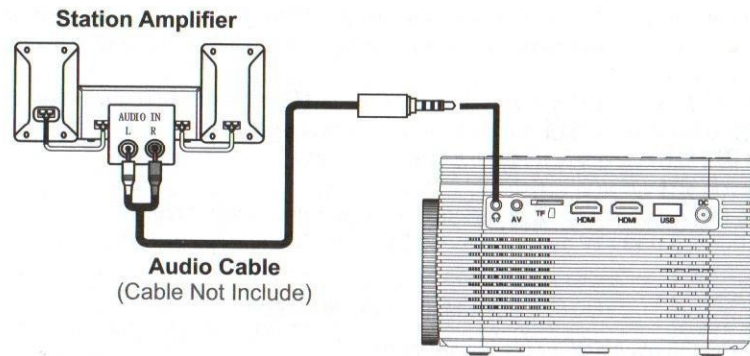

Install USB Device and Micro SD Card

Follow us to the USB and TF card Turn off the unit before installing USB / TF card

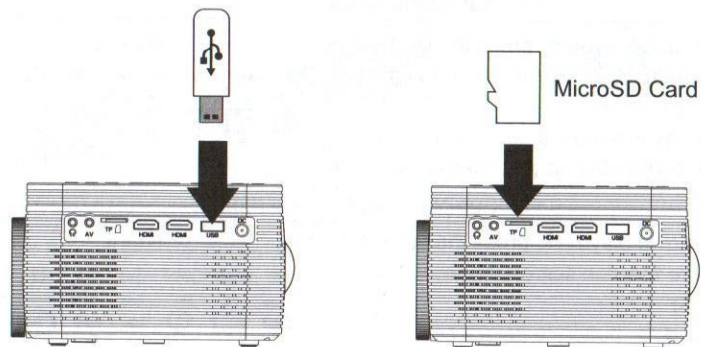

Using the TF card and USB playback (Media Player)

Follow the picture below to connect the HDMI cable and the device.

1. Turn off the device in front of the USB / TF card.
 2. Install the USB device to the USB port.
 3. After connect, press the button to turn on and the power indicator light GREEN.
 4. Press the /SOURCE button to enter and use buttons to search the MEDIAPLAYER mode.
 5. After selection, use buttons to search the MUSIC / PHOTO / MOVIE icon and press the button to enter. If necessary, use the / button to select TF card or USB and press the button to enter.
 6. Use buttons to search the correct file and press the button to preview playback file and press button of unit or button of remote to start playback.
 7. Press button to fast search forward and rewind.
 8. Press button to search next or previous file.
 9. During playback, press the button to pause and press again to resume.
- NOTE:** Remove USB / TF device, press the button to turn off power FIRST.

Sub-Menu on Photo screen

When photo playback, press the button and more function screen show on lower (figure 1).

2. Use the / button to select icon and press the button to play special function.

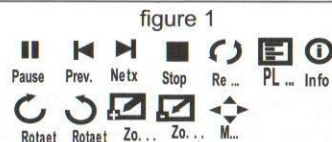

Sub-Menu on Music screen

When music playback, press the button and more function screen show on lower (figure 2)

Use the / button to select icon and press the button to play special function.

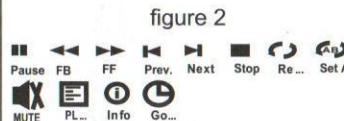

Sub-Menu on Movie screen

When movie playback, press the button and more function screen. show on lower (figure 3)

Use the / button to select icon and press the button to play special function.

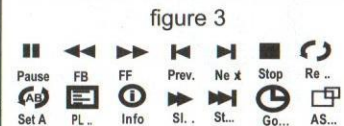

Using DVD playback

1. Press the button to turn on unit and the power indicator light GREEN.
2. Press the /SOURCE button to enter and use buttons to search the DVD mode.
3. Open the disc cover and insert a playable DVD or CD disc, make sure the label side is facing up, and then close disc cover.
4. The player will scan the disc, and then the playback will start automatically. If a disc menu appears on the screen, see "Using the disc menu" for details.
5. Press button to fast search forward and rewind.
6. Press button to search next or previous file.
7. During playback, press the button to pause and press again to resume.

Disc handling:

- Do not leave discs near heat sources, in direct sunlight, or in high humidity.
- Store discs in their cases when they are not being used.
- Stacking discs or standing them at an angle without putting them in the case can cause the disc to warp.
- Do not touch the disc surface when handling a disc; hold it by the edges.
- Fingerprints, dust, dirt or scratches on the disc can distort the picture or reduce sound quality. Always handle carefully and make sure discs are clean before use.
- Do not stick paper or tape onto the disc.
- Do not write on the disc with a marker, etc. Clean discs using a soft cloth, lightly wiping from the center outwards.
- Do not use solvents such as benzene, commercially available cleaner not intended for CDs or anti-static spray intended for vinyl LPs, as these may damage your disc.

INPUT SOURCE
AV
HDMI 1
HDMI 2
VGA
DVD
Media Player
OK

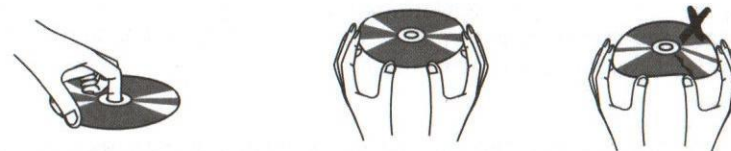

You must pay attention to the following points:

1. Place the DVD on the projector before turning it on.
2. Do not place the projector upright, as it will damage the DVD.

Specifications

Light Source Type	LED
HDMI Input Supported Video Resolution	1080P, 1080i , 720p , 576i , 480p , and 480i
Resolution	1080P Support
Power Consumption	Operating 48W ; stand by 0.8W
Power Input Connect Included Adapter	DC 12V 4A
Included Adapter Connect DC input of unit	Input : AC100-240V , 50/60HZ Output : DC12V, 4A
Display Color	7000-8000K
Signal Port	Video/ VGA/HDMI
USB Port	Support USB device up to 32GB Support format mpeg1,mpeg2,mpeg4,mp3.jpeg
MICRO SD	Support MICRO SD card up to 32GB Support format mpeg1,mpeg2,mpeg4,mp3.jpeg
Weight	1KG
Dimension	203x 167x 98 mm

Troubleshooting

Before resorting the maintenance service, please kindly check by yourself with the following chart.

No Image is Projected or a "No Signal" message is displayed	<ol style="list-style-type: none"> 1. Power light is on. If it is not on, check the projector is plugged into the mains, that the socket is switched on, and then presses the power button on the projector. 2. Check the lens cover has been removed. 3. Check the cables are clearly attached and installed as per the User Manual. 4. The image source may not be correct. Press the Source button on the control panel. 5. Check in the menu section under Video input signal to make sure that has been set correctly.
The lamp (lamp) switches off after a certain time	<p>Is the warning light indicator red? If so, the projector is over heating which turns off the light off automatically.</p> <ol style="list-style-type: none"> 1. Leave the projector to cool for a few moments. 2. Once cooled, check nothing is blocking the ventilation vents.
The image is wider at the top / bottom of the screen.	<p>This is called keystone and is due to the projection. To correct the projectors inbuilt keystone function to adjust the image.</p>
Stains on the screen.	<p>Using a vacuum cleaner to clean the lens. If cleaning does not resolve things, please contact your support provider for further assistance.</p>
The image brightness has faded	<p>This could be caused by the ambient light in the room. If not, the chances are you need to replace the lamp (bulb)</p>

Warranty

Should you experience any problems not covered by the FAQ, please don't hesitate to email us at:

United States customer service: USTYY002@bigasuo.co.uk

Japan customer service: TYYJP@BIGASUO.jp

We will offer solutions to your issues or a direct replacement/refund without delays